

## High Brightness SMT LED

Color	Type	Technology	Angle of half intensity $\pm\varphi$
Yellow	TLME3100	AlInGaP	60°

### Description

These new devices have been designed to meet the increasing demand for AlInGaP technology.

The package of the TLME3100 is the PL-CC-2 (equivalent to a size B tantalum capacitor).

It consists of a lead frame which is surrounded with a white thermoplast. The reflector inside this package is filled up with clear epoxy.

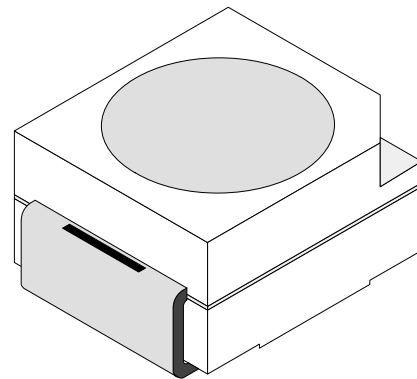

94 8553

### Features

- SMT LEDs with exceptional brightness
- Luminous intensity categorized
- Compatible with automatic placement equipment
- EIA and ICE standard package
- Compatible with infrared, vapor phase and wave solder processes according to CECC
- Available in 8 mm tape
- Low profile package
- Non diffused lens: excellent for coupling to light pipes and backlighting
- Low power consumption
- Luminous intensity ratio in one packaging unit  
 $I_{Vmax}/I_{Vmin} \leq 2.0$

### Applications

Automotive: backlighting in dashboards and switches

Telecommunication: indicator and backlighting in telephone and fax

Indicator and backlight for audio and video equipment

Indicator and backlight in office equipment

Flat backlight for LCDs, switches and symbols

General use

## TLME3100

### Absolute Maximum Ratings

$T_{amb} = 25^{\circ}\text{C}$ , unless otherwise specified

#### TLME3100

Parameter	Test Conditions	Symbol	Value	Unit
Reverse voltage		$V_R$	5	V
DC forward current	$T_{amb} \leq 65^{\circ}\text{C}$	$I_F$	25	mA
Surge forward current	$t_p \leq 10 \mu\text{s}$	$I_{FSM}$	0.1	A
Power dissipation	$T_{amb} \leq 65^{\circ}\text{C}$	$P_V$	65	mW
Junction temperature		$T_j$	100	$^{\circ}\text{C}$
Operating temperature range		$T_{amb}$	-40 to +100	$^{\circ}\text{C}$
Storage temperature range		$T_{stg}$	-55 to +100	$^{\circ}\text{C}$
Soldering temperature	$t \leq 5 \text{ s}$	$T_{sd}$	260	$^{\circ}\text{C}$
Thermal resistance junction/ambient	mounted on PC board (pad size > 16 mm <sup>2</sup> )	$R_{thJA}$	400	K/W

### Optical and Electrical Characteristics

$T_{amb} = 25^{\circ}\text{C}$ , unless otherwise specified

#### Yellow (TLME3100)

Parameter	Test Conditions	Type	Symbol	Min	Typ	Max	Unit
Luminous intensity	$I_F = 10 \text{ mA}$		$I_V$	25	50		mcd
Dominant wavelength	$I_F = 10 \text{ mA}$		$\lambda_d$	581	588	594	nm
Peak wavelength	$I_F = 10 \text{ mA}$		$\lambda_p$		590		nm
Angle of half intensity	$I_F = 10 \text{ mA}$		$\phi$		$\pm 60$		deg
Forward voltage	$I_F = 20 \text{ mA}$		$V_F$		2	2.6	V
Reverse voltage	$I_R = 10 \mu\text{A}$		$V_R$	5			V
Junction capacitance	$V_R = 0, f = 1 \text{ MHz}$		$C_j$		15		pF

## Typical Characteristics ( $T_{amb} = 25^{\circ}\text{C}$ , unless otherwise specified)

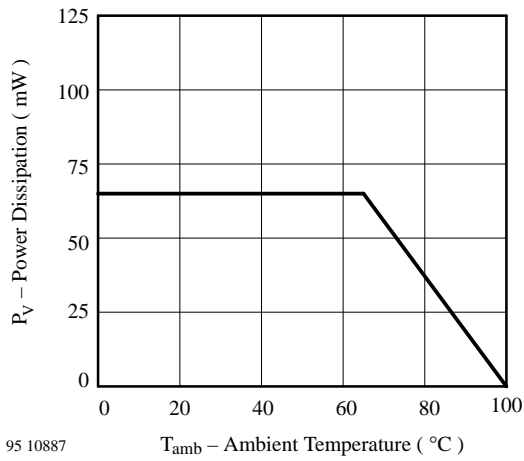

Figure 1. Power Dissipation vs. Ambient Temperature

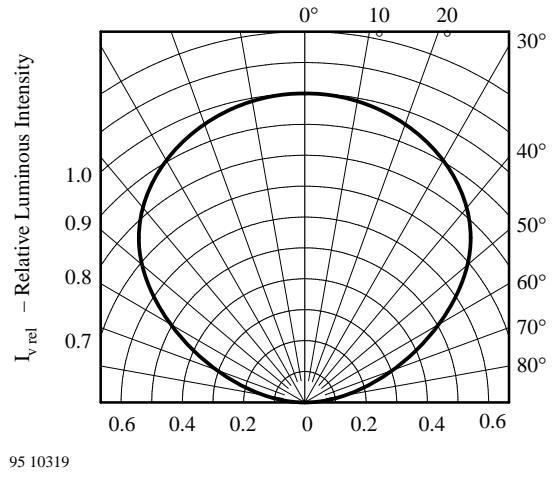

Figure 4. Rel. Luminous Intensity vs. Angular Displacement

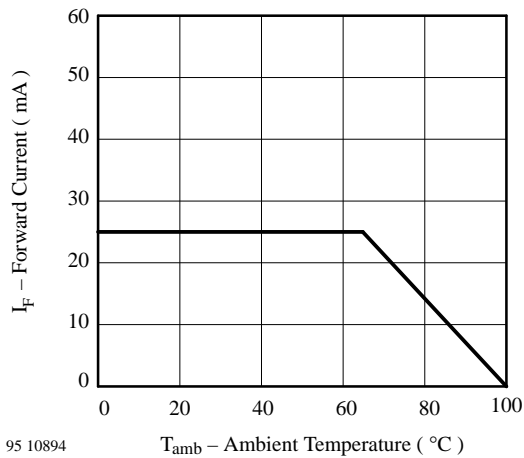

Figure 2. Forward Current vs. Ambient Temperature

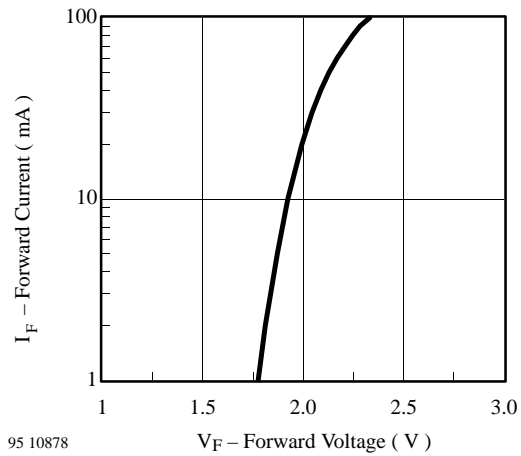

Figure 5. Forward Current vs. Forward Voltage

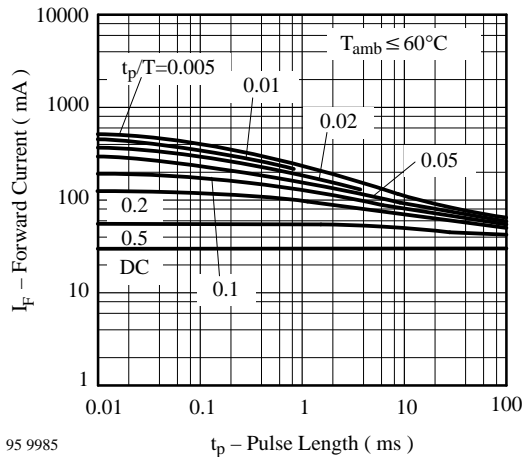

Figure 3. Forward Current vs. Pulse Length

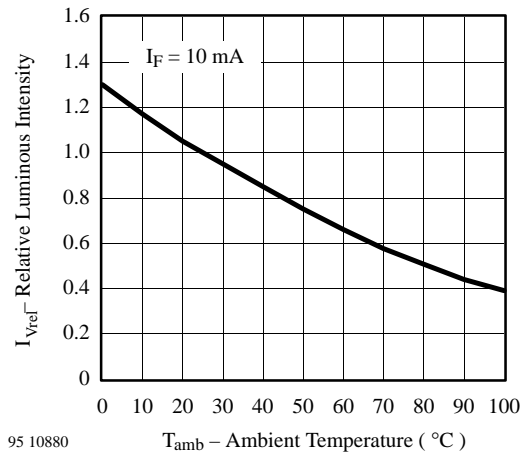

Figure 6. Rel. Luminous Intensity vs. Ambient Temperature

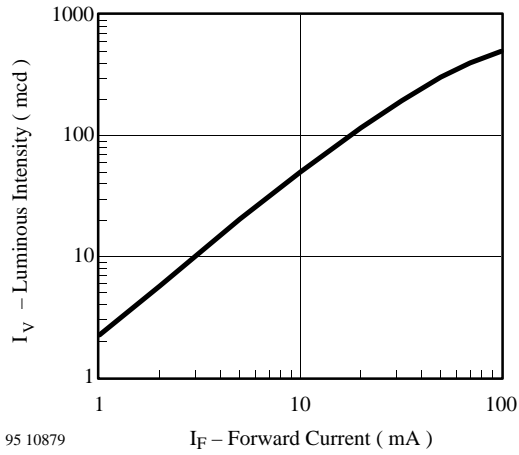

Figure 7. Luminous Intensity vs. Forward Current

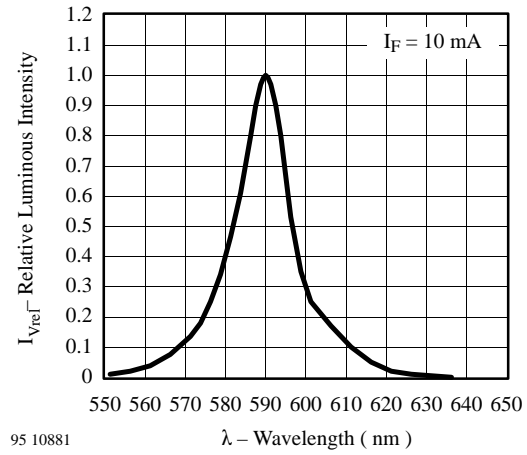
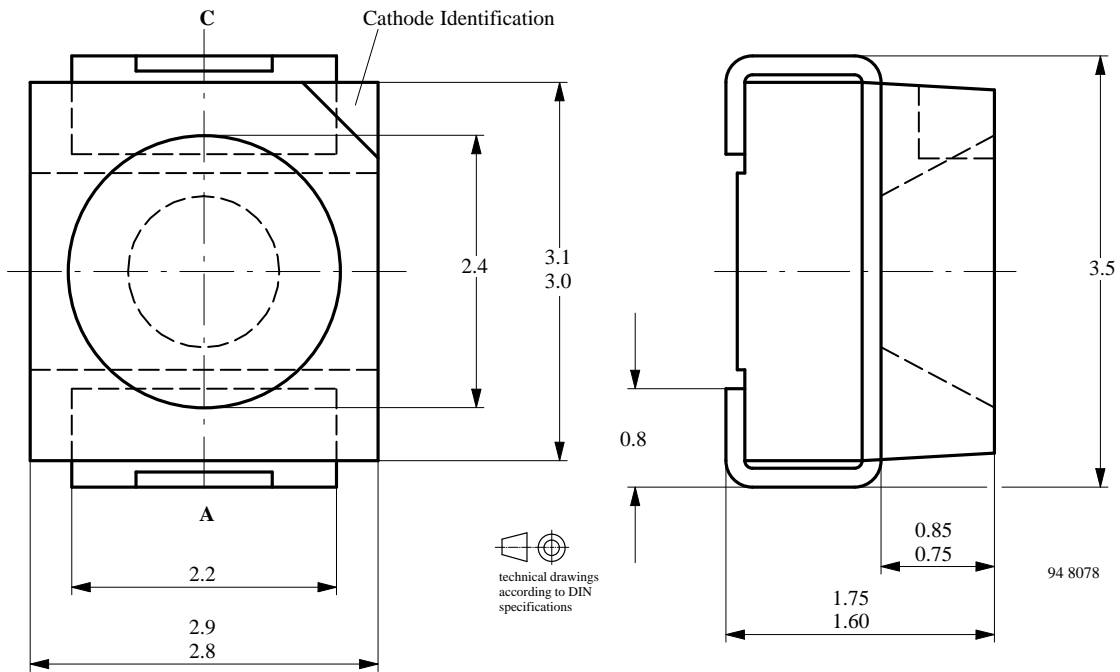
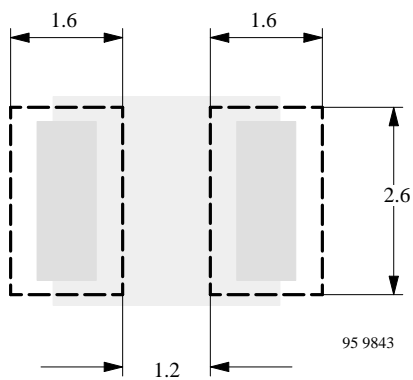

Figure 8. Relative Luminous Intensity vs. Wavelength

## Dimensions in mm



## PCB Layout in mm



## Ozone Depleting Substances Policy Statement

It is the policy of **TEMIC TELEFUNKEN microelectronic GmbH** to

1. Meet all present and future national and international statutory requirements.
2. Regularly and continuously improve the performance of our products, processes, distribution and operating systems with respect to their impact on the health and safety of our employees and the public, as well as their impact on the environment.

It is particular concern to control or eliminate releases of those substances into the atmosphere which are known as ozone depleting substances (ODSs).

The Montreal Protocol (1987) and its London Amendments (1990) intend to severely restrict the use of ODSs and forbid their use within the next ten years. Various national and international initiatives are pressing for an earlier ban on these substances.

**TEMIC TELEFUNKEN microelectronic GmbH** semiconductor division has been able to use its policy of continuous improvements to eliminate the use of ODSs listed in the following documents.

1. Annex A, B and list of transitional substances of the Montreal Protocol and the London Amendments respectively
2. Class I and II ozone depleting substances in the Clean Air Act Amendments of 1990 by the Environmental Protection Agency (EPA) in the USA
3. Council Decision 88/540/EEC and 91/690/EEC Annex A, B and C (transitional substances) respectively.

**TEMIC** can certify that our semiconductors are not manufactured with ozone depleting substances and do not contain such substances.

**We reserve the right to make changes to improve technical design and may do so without further notice.**

Parameters can vary in different applications. All operating parameters must be validated for each customer application by the customer. Should the buyer use TEMIC products for any unintended or unauthorized application, the buyer shall indemnify TEMIC against all claims, costs, damages, and expenses, arising out of, directly or indirectly, any claim of personal damage, injury or death associated with such unintended or unauthorized use.

TEMIC TELEFUNKEN microelectronic GmbH, P.O.B. 3535, D-74025 Heilbronn, Germany  
Telephone: 49 (0)7131 67 2831, Fax number: 49 (0)7131 67 2423